

71701-00S CR 1700-W45F173-00S

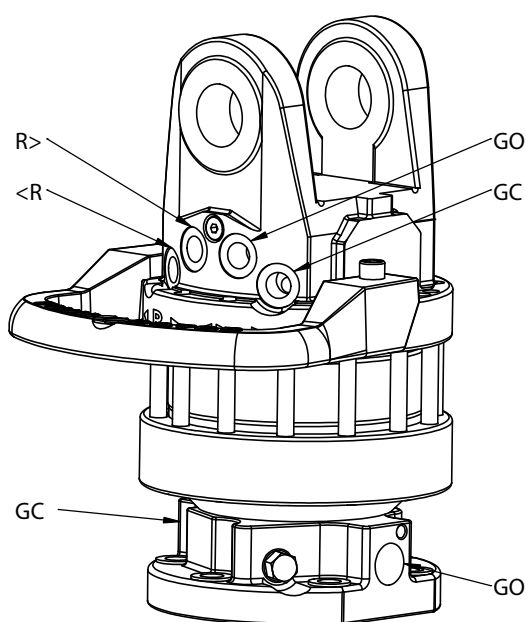

Rotation angle	Unlimited
Max pressure (R)	250 bar
Max pressure grapple open (GO)	300 bar
Max pressure grapple close (GC)	300 bar
Capacity	1000 cm ³
Torque (250 bar)	3300 Nm
Max axial load static	160 kN
Max axial load dynamic	60 kN
Weight	67 kg
Connections	G1/2
Max oil flow	25 LPM
Connectors	-

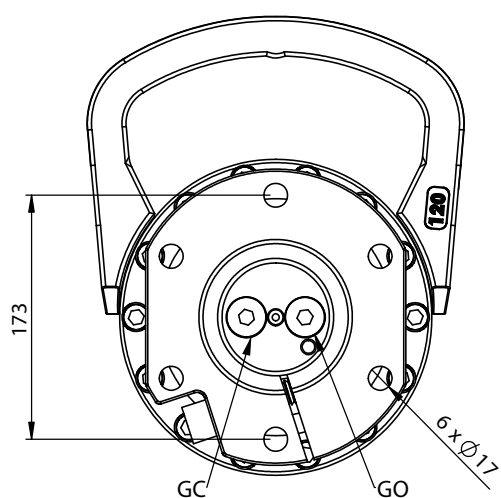
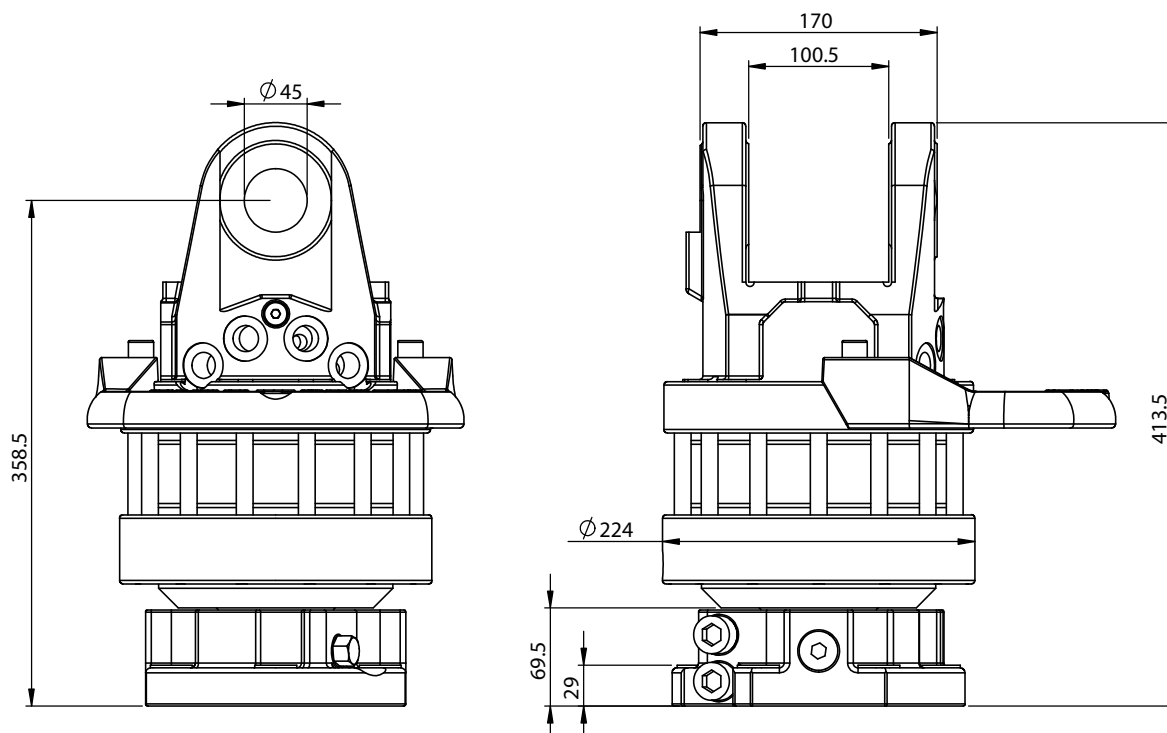