

# 71610 CRM 1600H-X45F173

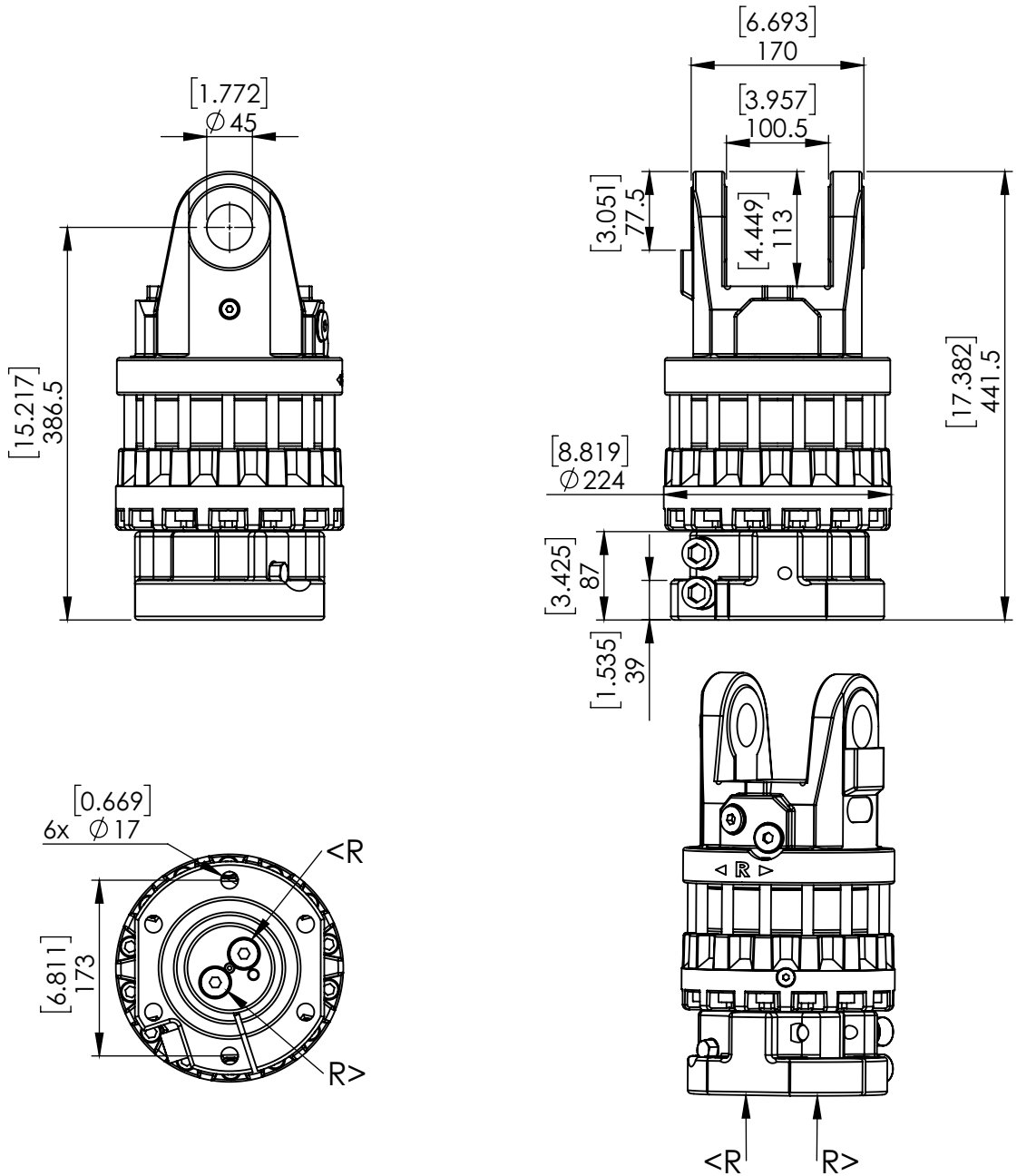

ROTATION ANGLE	UNLIMITED	
MAX PRESSURE (R) [BAR/PSI]	250	3626
MAX PRESSURE (GO) [BAR/PSI]	300	4351
MAX PRESSURE (GC) [BAR/PSI]	300	4351
DISPLACEMENT [cm <sup>3</sup> /Inch <sup>3</sup> ]	949	58
TORQUE [Nm/lbf-ft]	3600	2655
MAX AXIAL LOAD STATIC [KN/lbf]	160	35969
MAX AXIAL LOAD DYNAMIC [KN/lbf]	80	17985
MAX AXIAL NEGATIVE LOAD STATIC [KN/lbf]	90	20233
MAX AXIAL NEGATIVE LOAD DYNAMIC [KN/lbf]	45	10116
WEIGHT [kg/lb]	73	161
CONNECTIONS	G1/2"	G1/2"
REQ. OIL FLOW FOR ROTATION [LPM/GPM]	30	7.9