

71600 CRH 1600-X45F173

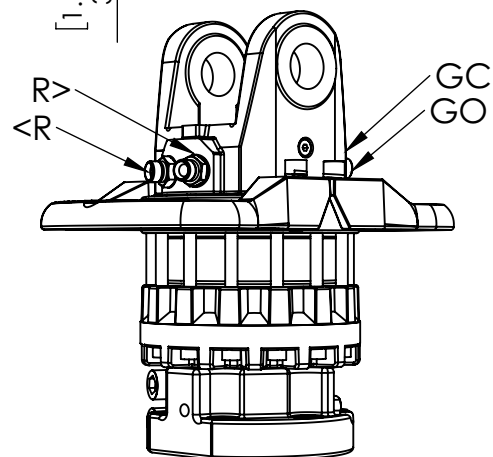
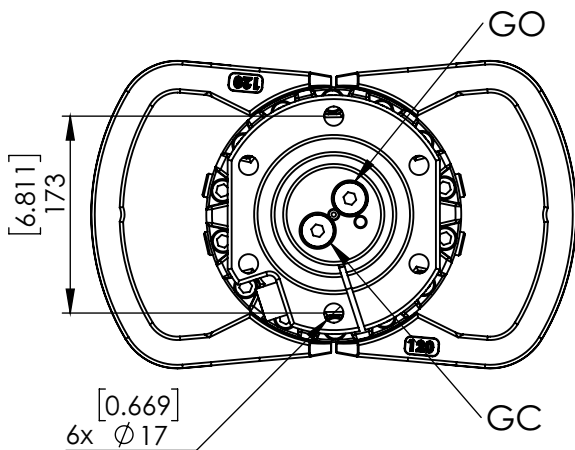
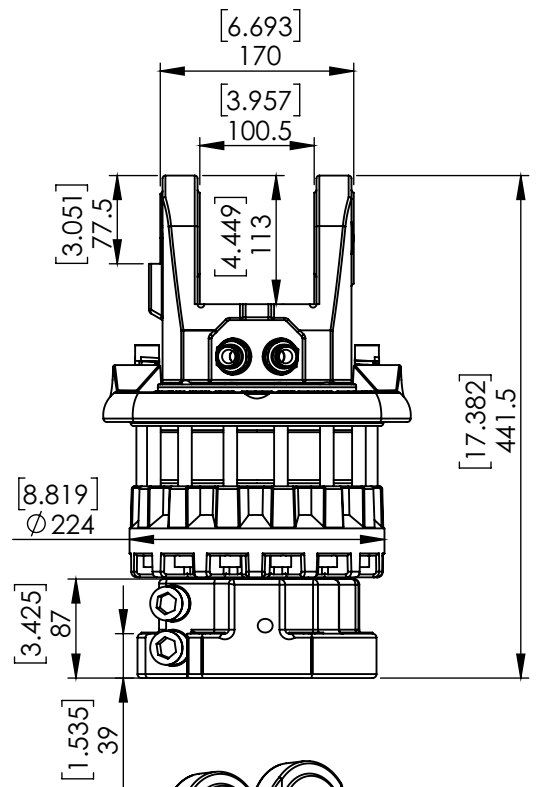
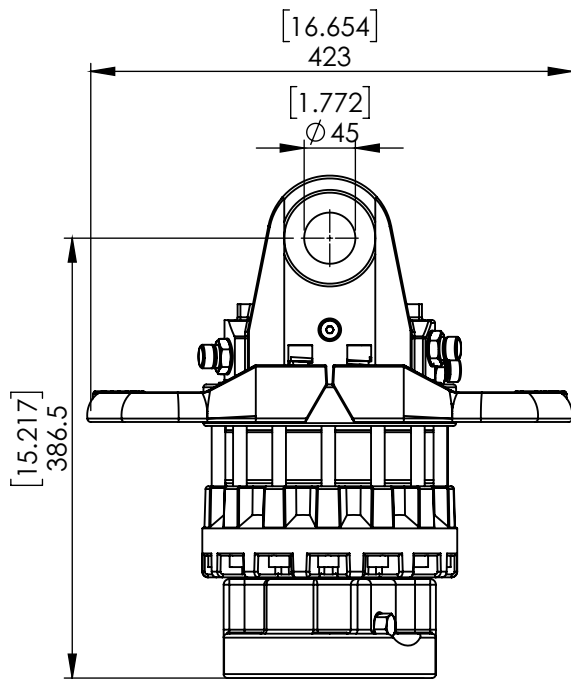

ROTATION ANGLE	UNLIMITED	
MAX PRESSURE (R) [BAR/PSI]	250	3626
MAX PRESSURE (GO) [BAR/PSI]	300	4351
MAX PRESSURE (GC) [BAR/PSI]	300	4351
DISPLACEMENT [cm ³ /Inch ³]	949	58
TORQUE [Nm/lbf-ft]	3600	2655
MAX AXIAL LOAD STATIC [KN/lbf]	160	35969
MAX AXIAL LOAD DYNAMIC [KN/lbf]	80	17985
MAX AXIAL NEGATIVE LOAD STATIC [KN/lbf]	90	20233
MAX AXIAL NEGATIVE LOAD DYNAMIC [KN/lbf]	45	10116
WEIGHT [kg/lb]	79	174
CONNECTIONS	G1/2"	G1/2"
MAXIMUM OIL FLOW [LPM/GPM]	30	7.9