

71201 CRH 1200-W45F173

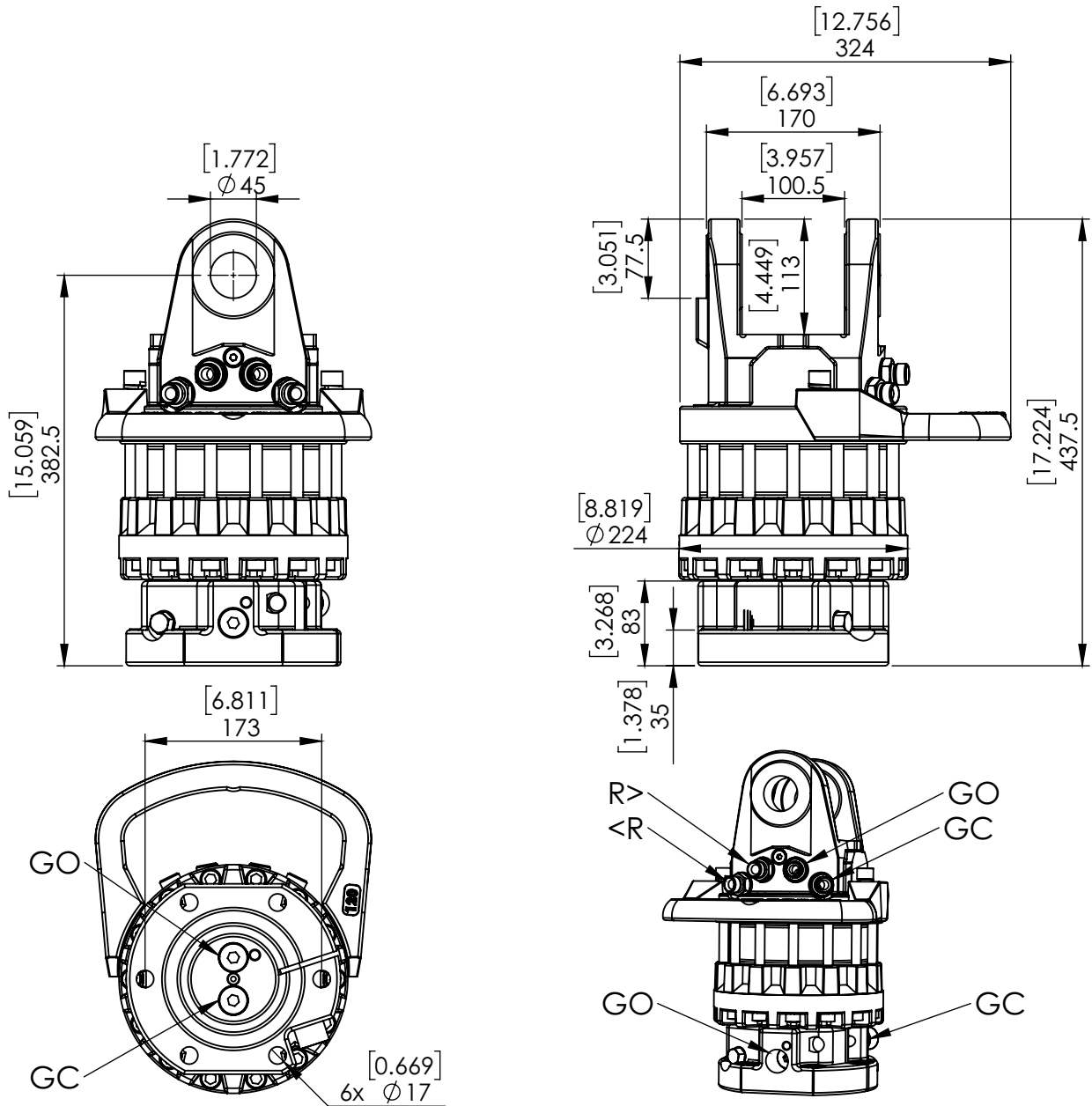

ROTATION ANGLE	UNLIMITED	
MAX PRESSURE (R) [BAR/PSI]	250	3626
MAX PRESSURE (GO) [BAR/PSI]	300	4351
MAX PRESSURE (GC) [BAR/PSI]	300	4351
DISPLACEMENT [cm ³ /Inch ³]	949	58
TORQUE [Nm/lbf-ft]	2900	2139
MAX AXIAL LOAD STATIC [KN/lbf]	120	26977
MAX AXIAL LOAD DYNAMIC [KN/lbf]	60	13489
MAX AXIAL NEGATIVE LOAD STATIC [KN/lbf]	90	20233
MAX AXIAL NEGATIVE LOAD DYNAMIC [KN/lbf]	45	10116
WEIGHT [kg/lb]	76	168
CONNECTIONS	G1/2"	G1/2"
MAXIMUM OIL FLOW [LPM/GPM]	25	6.6