

71100-00S CR 1100-X35F173-00S

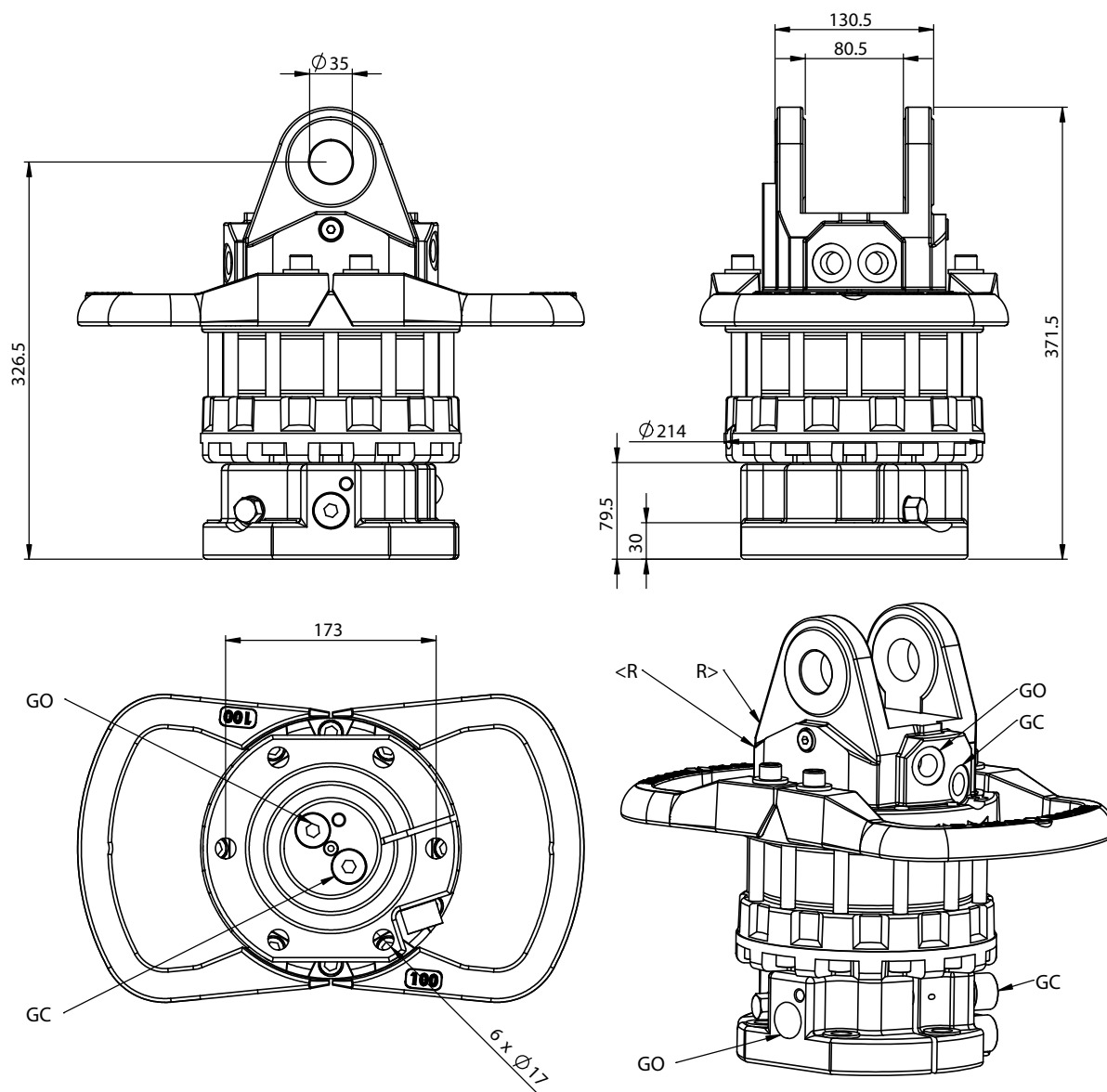

Rotation angle	Unlimited
Max pressure (R)	250 bar
Max pressure grapple open (GO)	300 bar
Max pressure grapple close (GC)	300 bar
Capacity	810 cm ³
Torque (250 bar)	2700 Nm
Max axial load static	100 kN
Max axial load dynamic	50 kN
Weight	59 kg
Connections	G1/2
Max oil flow	25 LPM
Connectors	-

