

71001 CRH 1000-W35F173

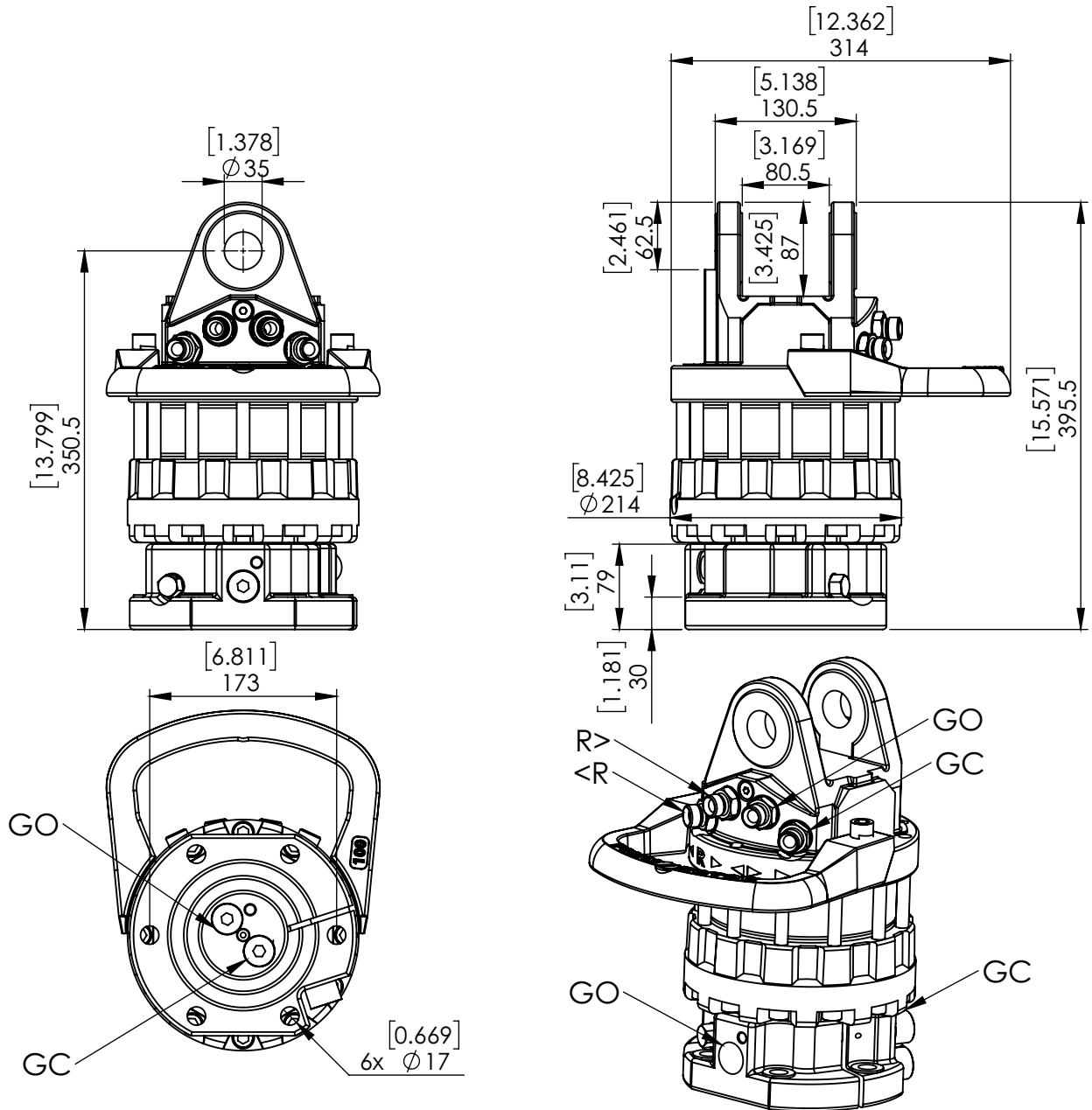

ROTATION ANGLE	UNLIMITED	
MAX PRESSURE (R) [BAR/PSI]	250	3626
MAX PRESSURE (GO) [BAR/PSI]	300	4351
MAX PRESSURE (GC) [BAR/PSI]	300	4351
DISPLACEMENT [cm ³ /Inch ³]	810	49
TORQUE [Nm/lbf-ft]	2700	1991
MAX AXIAL LOAD STATIC [KN/lbf]	100	22481
MAX AXIAL LOAD DYNAMIC [KN/lbf]	50	11240
MAX AXIAL NEGATIVE LOAD STATIC [KN/lbf]	80	17985
MAX AXIAL NEGATIVE LOAD DYNAMIC [KN/lbf]	40	8992
WEIGHT [kg/lb]	64	141
CONNECTIONS	G1/2"	G1/2"
MAXIMUM OIL FLOW [LPM/GPM]	25	6.6