

70810 CRM 800H-X35F173

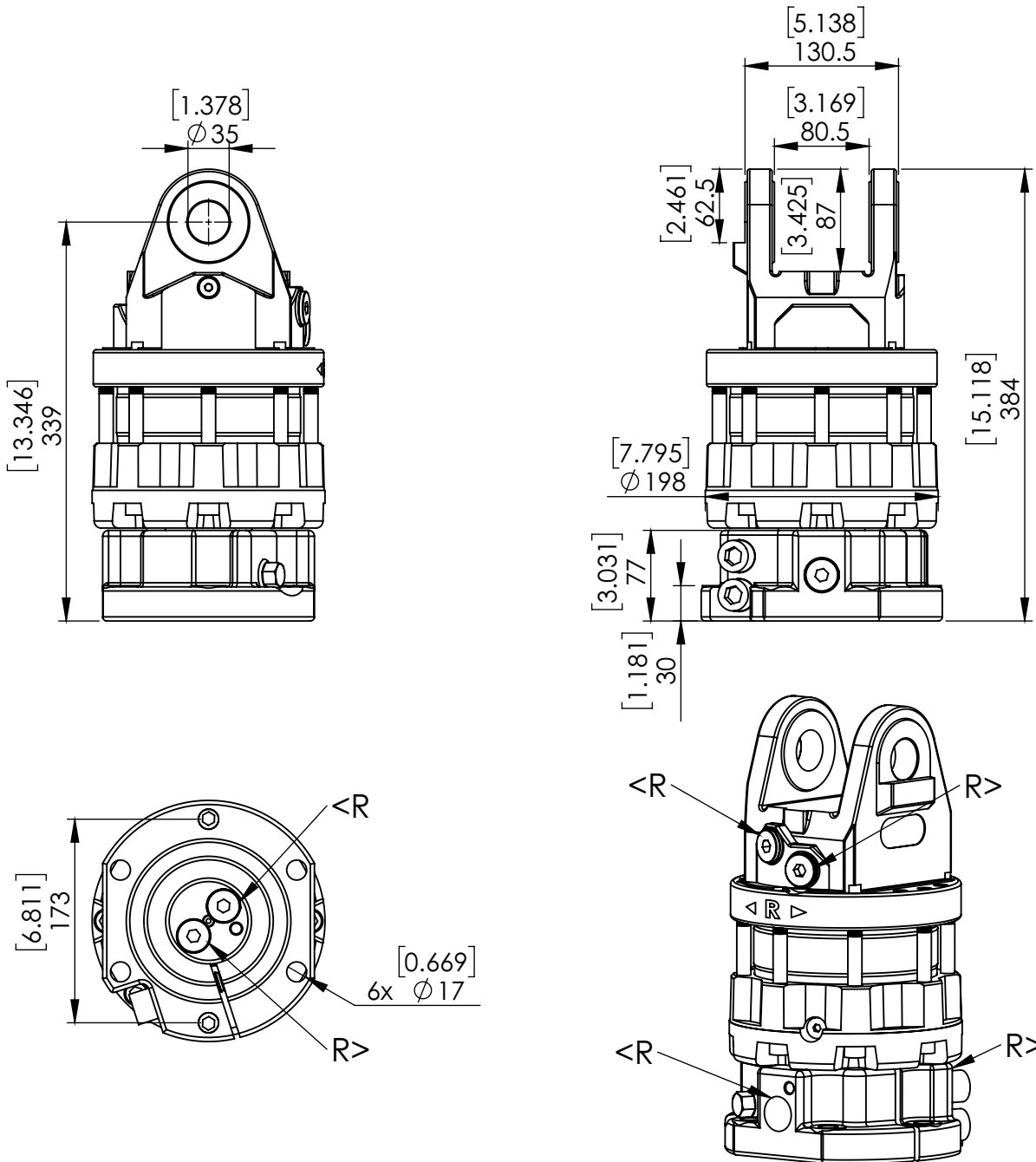

ROTATION ANGLE	UNLIMITED	
MAX PRESSURE (R) [BAR/PSI]	200	2901
DISPLACEMENT [cm ³ /Inch ³]	670	41
TORQUE [Nm/lbf-ft]	2000	1475
MAX AXIAL LOAD STATIC [KN/lbf]	80	17985
MAX AXIAL LOAD DYNAMIC [KN/lbf]	40	8992
MAX AXIAL NEGATIVE LOAD STATIC [KN/lbf]	40	8992
MAX AXIAL NEGATIVE LOAD DYNAMIC [KN/lbf]	20	4496
WEIGHT [kg/lb]	50	110
CONNECTIONS	G1/2"	G1/2"
MAXIMUM OIL FLOW [LPM/GPM]	25	6.6