

70605L-333 CR 600L-W35A30(D68)-333

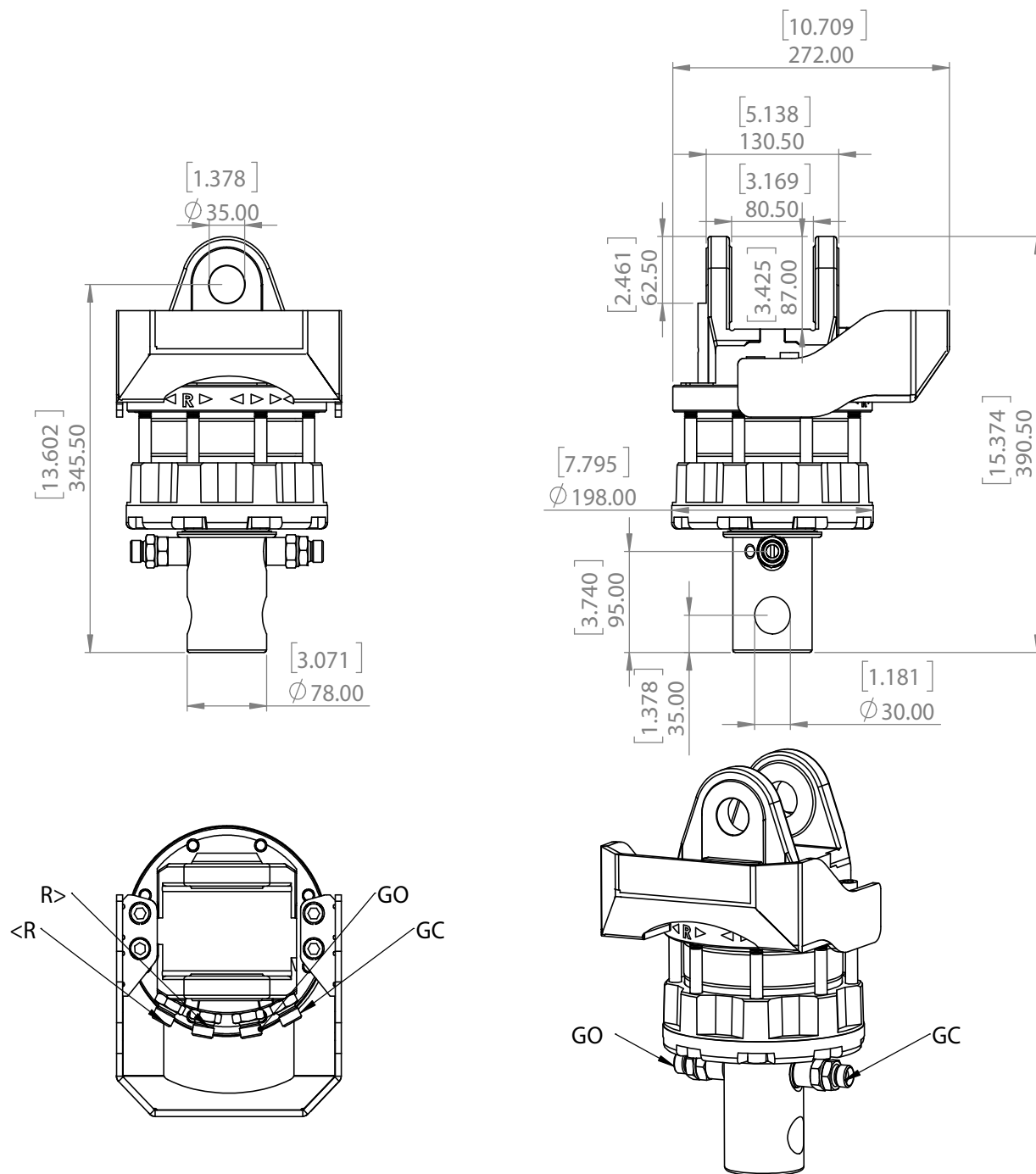

Rotation angle	Unlimited
Max pressure (R)	250 bar
Max pressure grapple open (GO)	200 bar
Max pressure grapple close (GC)	300 bar
Capacity	670 cm ³
Torque (250 bar)	1800 Nm
Max axial load static	60 kN
Max axial load dynamic	30 kN
Weight	37 kg
Connections	G1/2
Max oil flow	20 LPM
Connectors	BSP G1/2"

