

70505 CR 500-W30F173

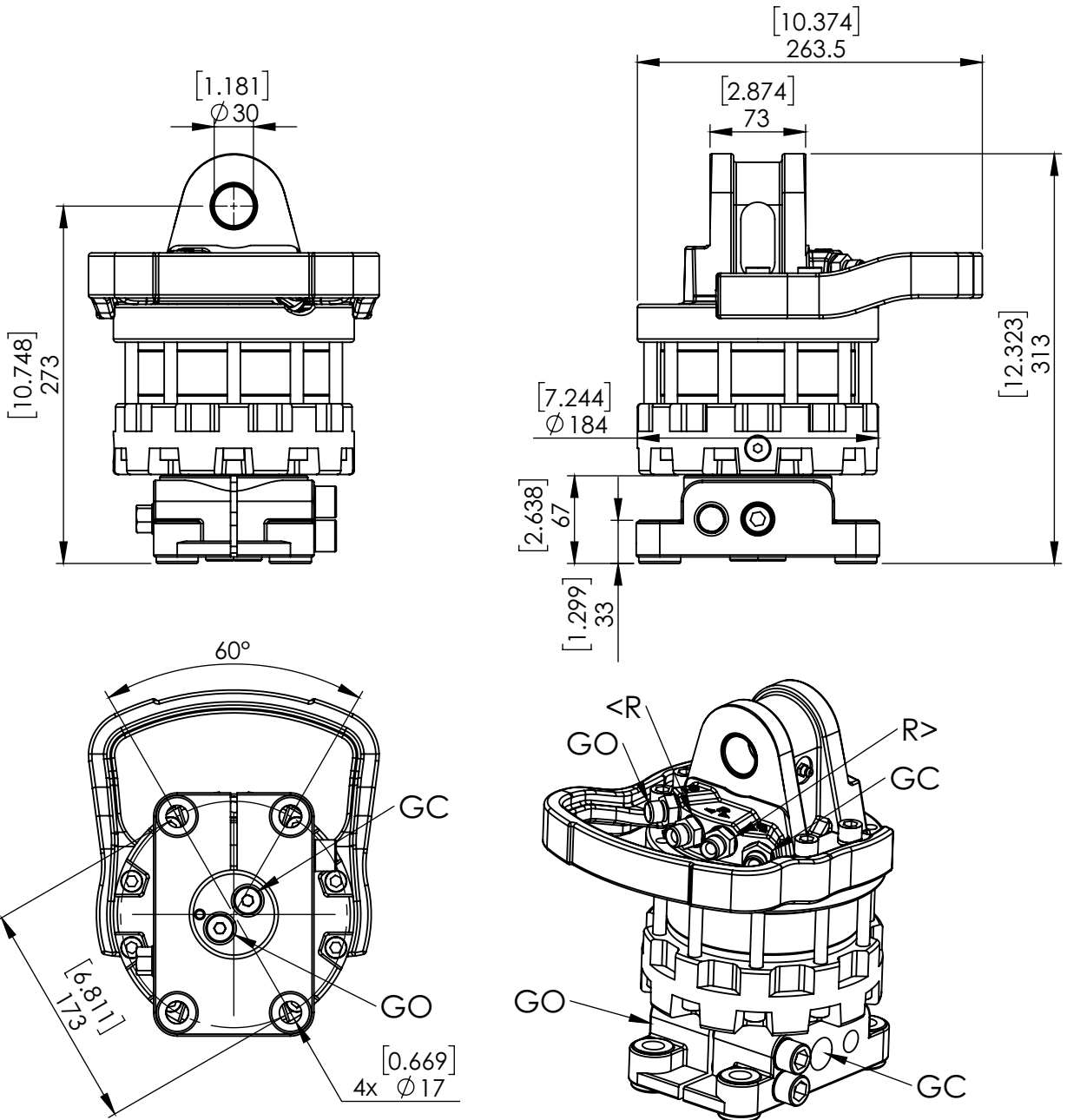

ROTATION ANGLE	UNLIMITED	
MAX PRESSURE (R) [BAR/PSI]	250	3625
MAX PRESSURE (GO) [BAR/PSI]	200	2901
MAX PRESSURE (GC) [BAR/PSI]	300	4351
DISPLACEMENT [cm ³ /Inch ³]	465	28
TORQUE [Nm/lbf-ft]	1400	1033
MAX AXIAL LOAD STATIC [KN/lbf]	55	12364
MAX AXIAL LOAD DYNAMIC [KN/lbf]	25	5620
WEIGHT [kg/lb]	35	77
CONNECTIONS	G3/8"	G3/8"
REQ. OIL FLOW FOR ROTATION [LPM/GPM]	20	5.3