

70505-00S CR 500-W30F173-00S

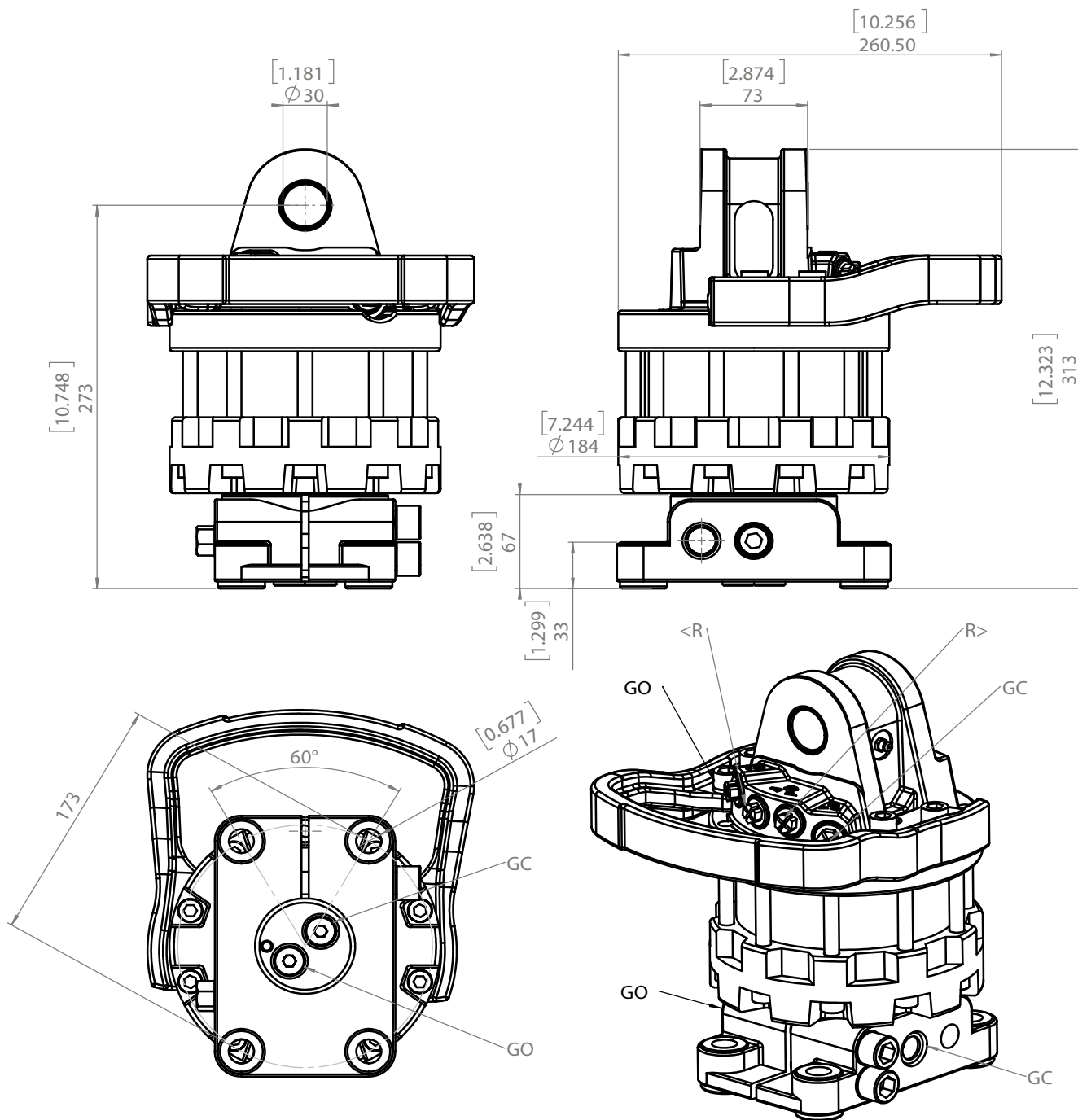

Rotation angle	Unlimited
Max pressure (R)	250 bar
Max pressure grapple open (GO)	200 bar
Max pressure grapple close (GC)	300 bar
Capacity	465 cm ³
Torque (250 bar)	1400 Nm
Max axial load static	55 kN
Max axial load dynamic	25 kN
Weight	22 kg
Connections	G3/8
Max oil flow	20 LPM
Connectors	-

