

70409 CR 400-W25F173

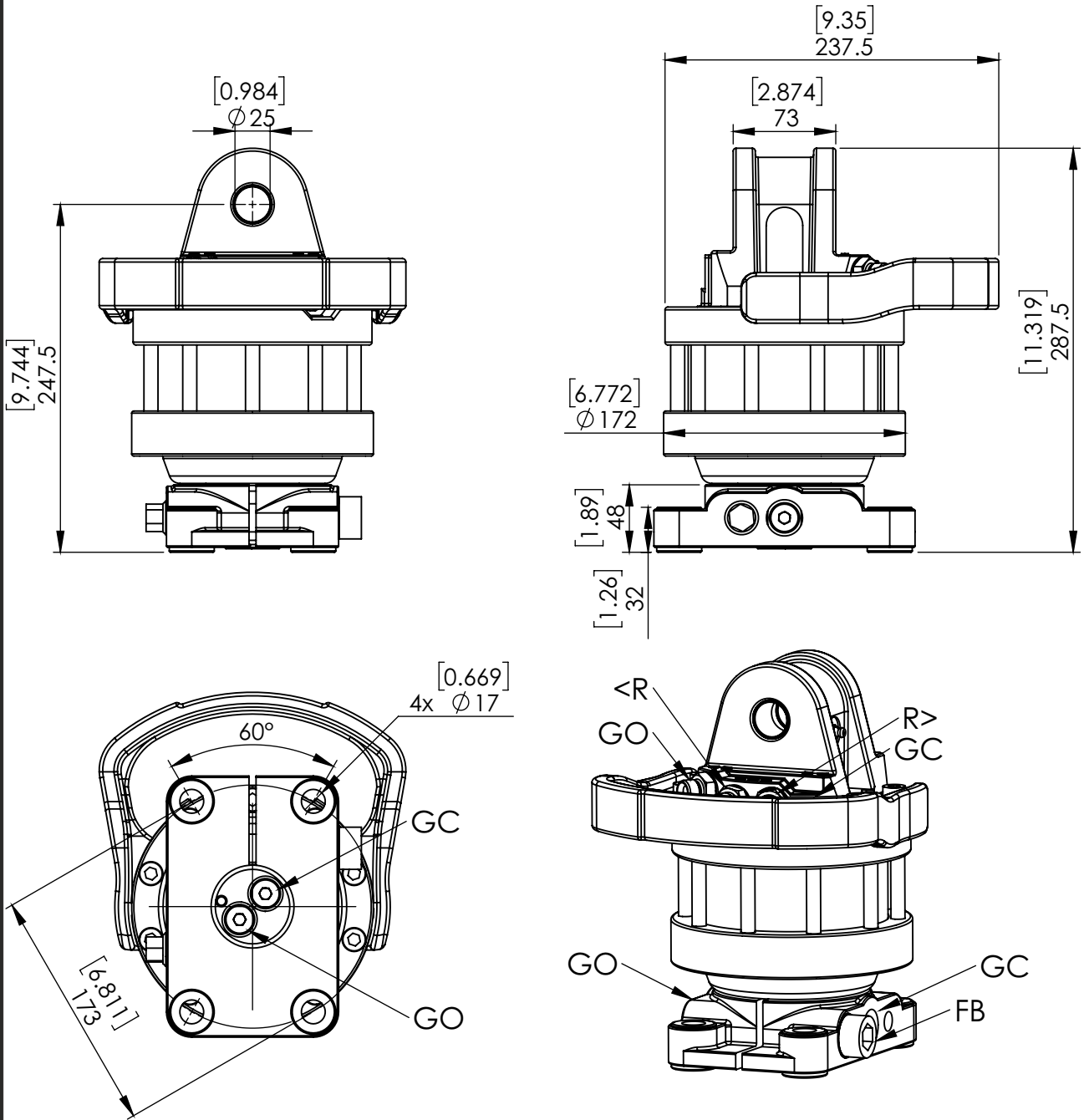

ROTATION ANGLE

UNLIMITED

MAX PRESSURE (R) [BAR/PSI]

250 3625

MAX PRESSURE (GO) [BAR/PSI]

200 2901

MAX PRESSURE (GC) [BAR/PSI]

300 4351

DISPLACEMENT [cm³/Inch³]

420 26

TORQUE [Nm/lbf-ft]

1100 811

MAX AXIAL LOAD STATIC [KN/lbf]

55 12364

MAX AXIAL LOAD DYNAMIC [KN/lbf]

27 6070

WEIGHT [kg/lb]

28 62

CONNECTIONS

G3/8" G3/8"

REQ. OIL FLOW FOR ROTATION [LPM/GPM]

20 5.3