

70409 CR 400-W25F173

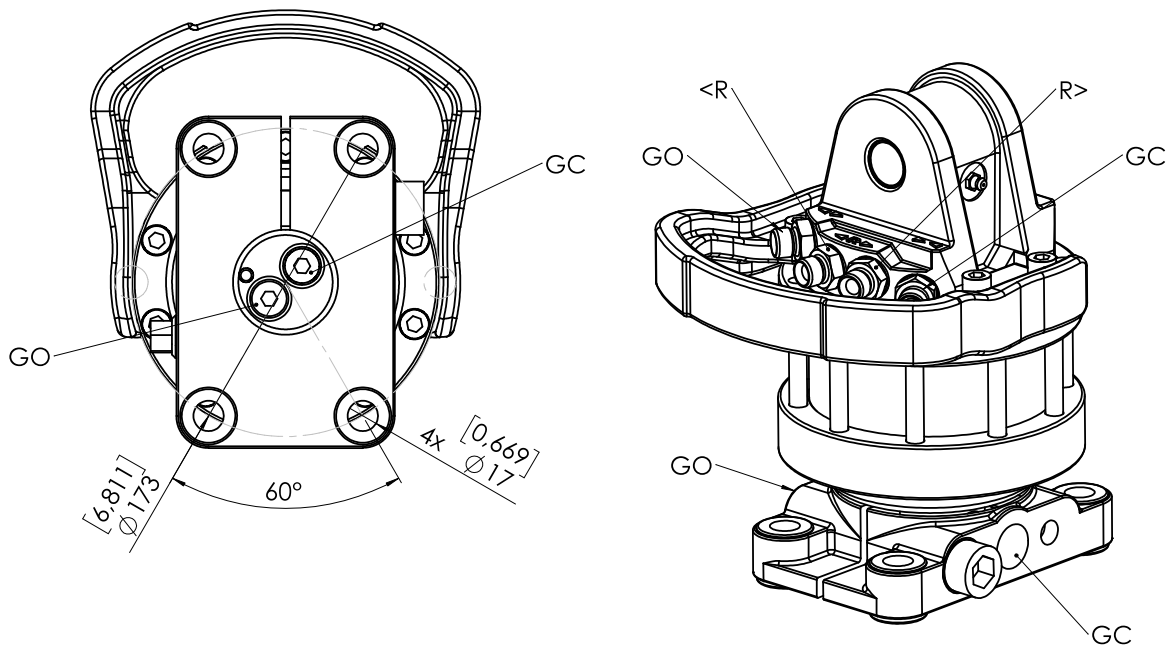
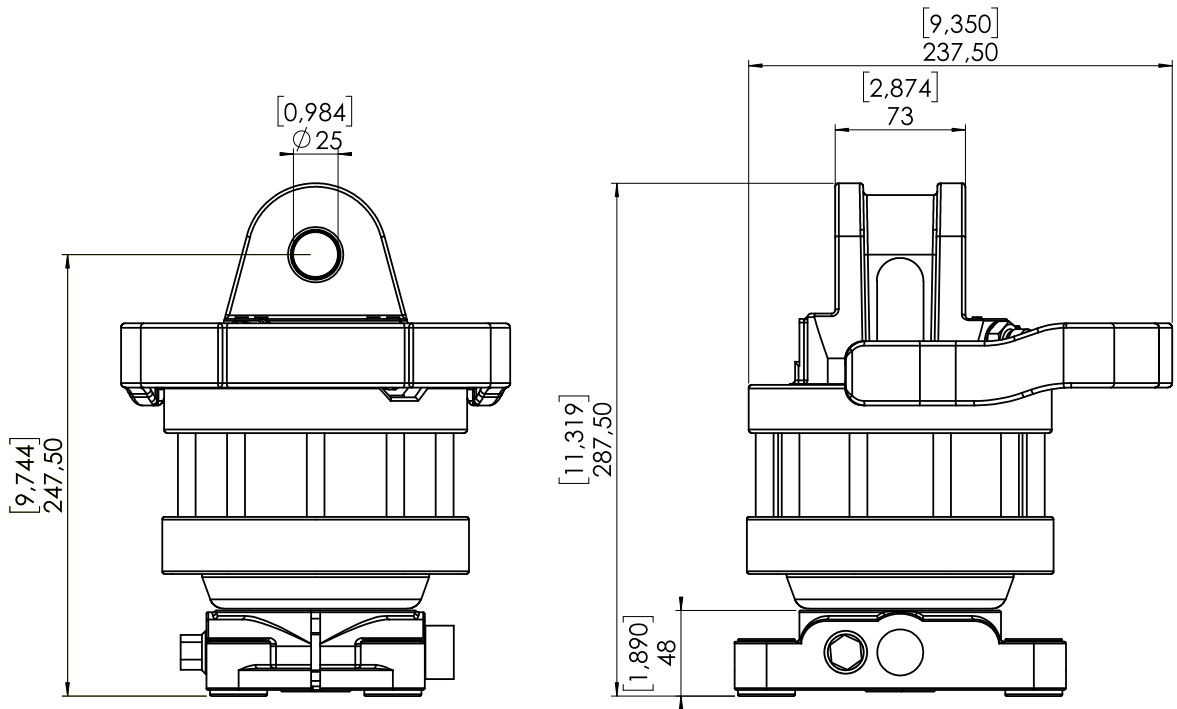

Rotation angle	unlimited °
Max rotation pressure (R)	250 bar
Max working pressure grapple open (GO)	200 bar
Max working pressure grapple closed (GC)	300 bar
Capacity	420 cm ³
Torque (250 bar)	1100 Nm
Max axial load (static)	40 kN
Max axial load (dynamic)	20 kN
Weight	28 kg
Required oil flow	20 lpm