

70405 CR 400-W25F140

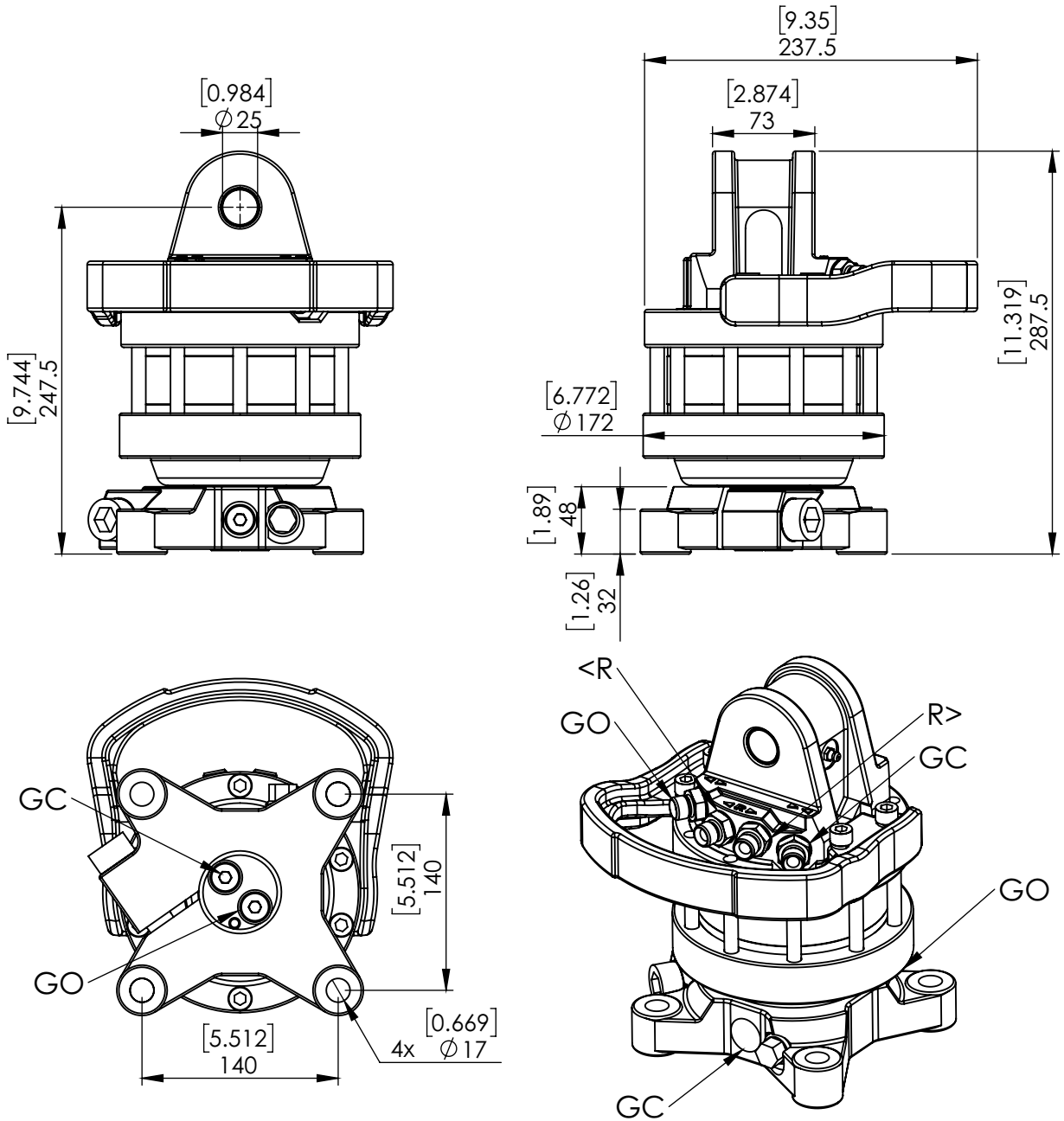

ROTATION ANGLE	UNLIMITED	
MAX PRESSURE (R) [BAR/PSI]	250	3625
MAX PRESSURE (GO) [BAR/PSI]	200	2901
MAX PRESSURE (GC) [BAR/PSI]	300	4351
DISPLACEMENT [cm3/Inch3]	420	26
TORQUE [Nm/lbf-ft]	1100	811
MAX AXIAL LOAD STATIC [KN/lbf]	45	10116
MAX AXIAL LOAD DYNAMIC [KN/lbf]	25	5620
WEIGHT [kg/lb]	28	62
CONNECTIONS	G3/8"	G3/8"
MAXIMUM OIL FLOW [LPM/GPM]	20	5.3