

## 70405-00S CR 400-W25F140-00S

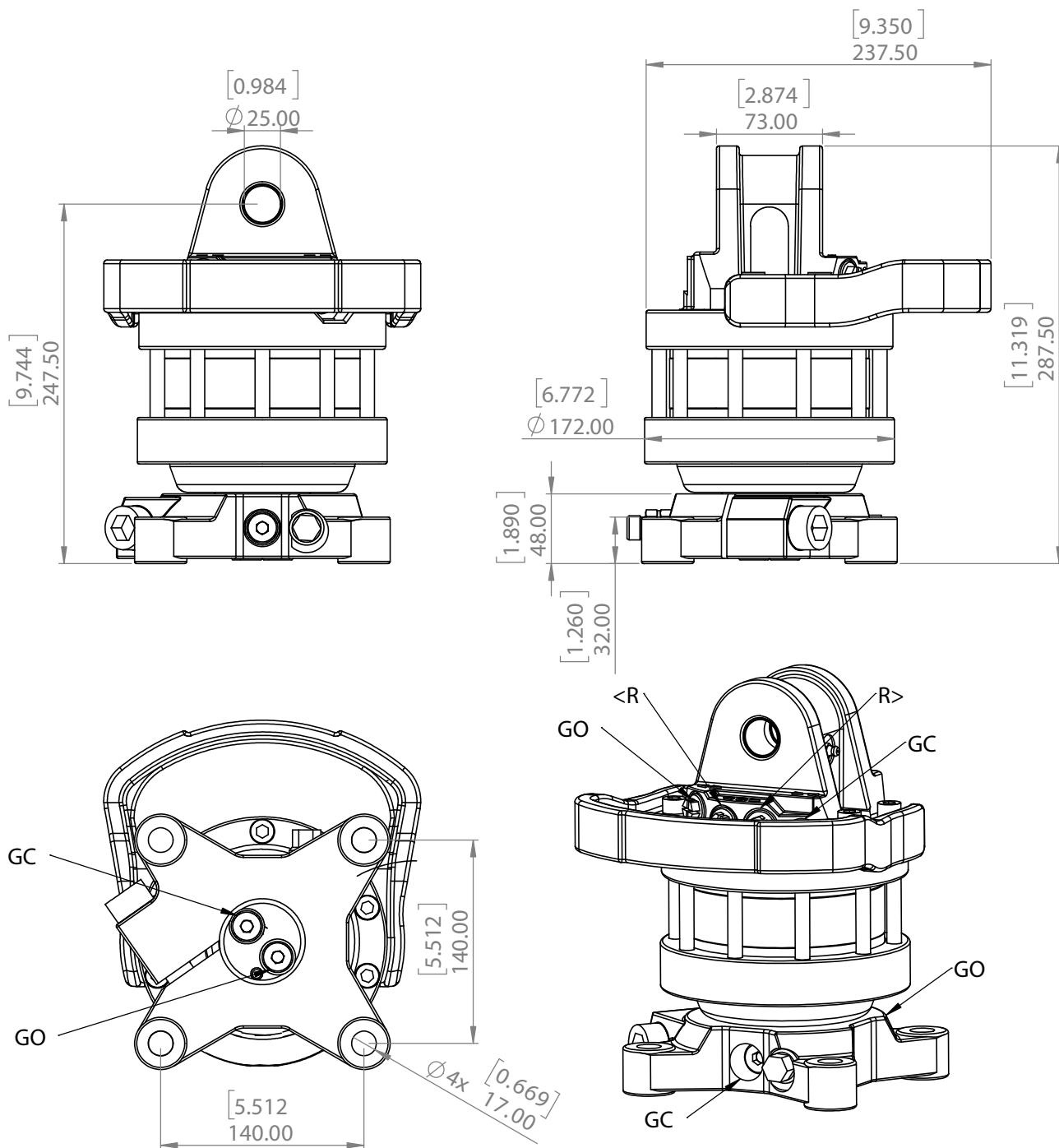

Rotation angle	Unlimited
Max pressure (R)	250 bar
Max pressure grapple open (GO)	200 bar
Max pressure grapple close (GC)	300 bar
Capacity	420 cm <sup>3</sup>
Torque (250 bar)	1100 Nm
Max axial load static	45 kN
Max axial load dynamic	25 kN
Weight	30 kg
Connections	G3/8
Max oil flow	20 LPM
Connectors	-

