

70402-222 CR 400-W25A30(D69)

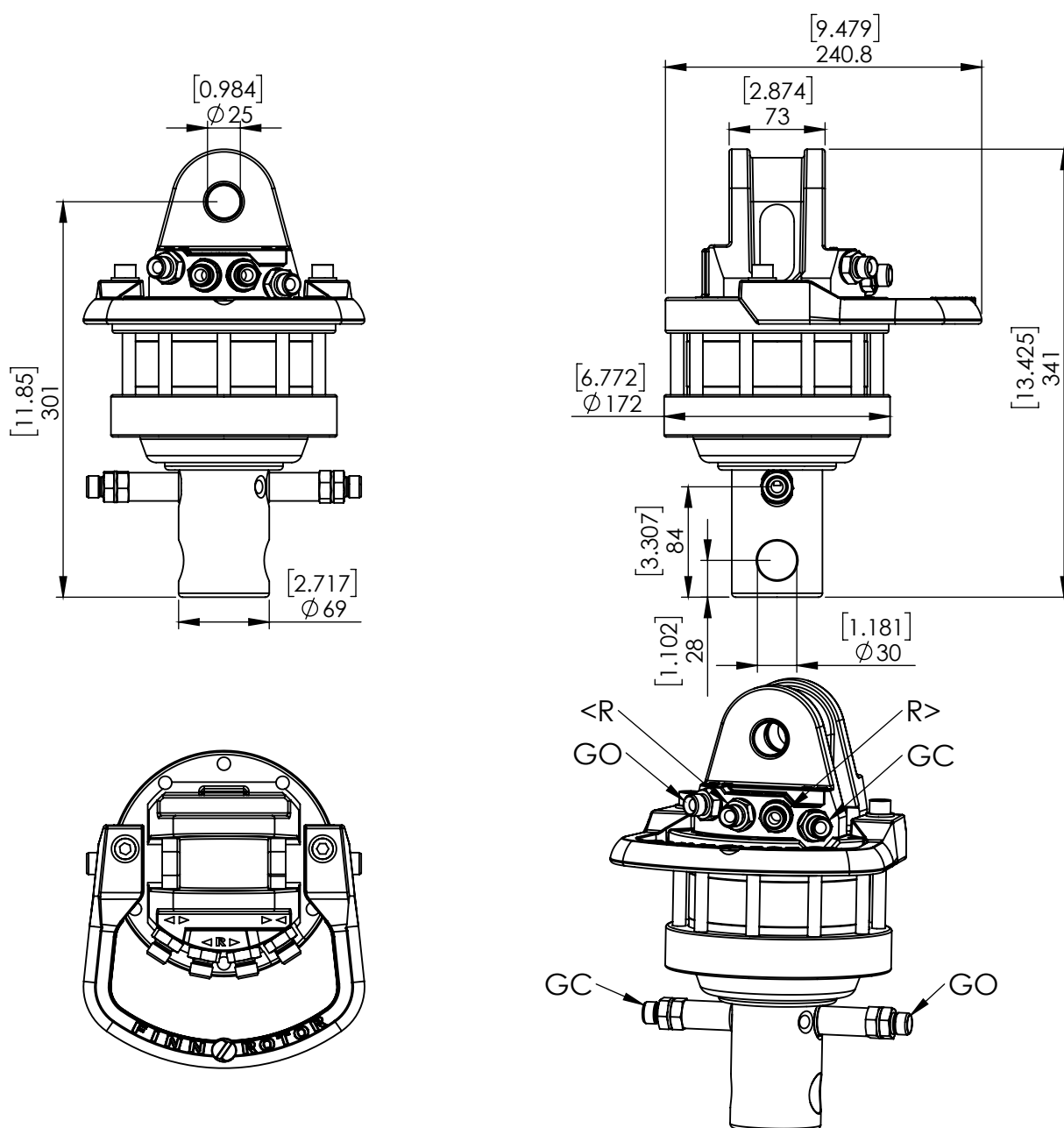

Rotation angle
 Max pressure (R)
 Max pressure grapple open (GO)
 Max pressure grapple close (GC)
 Capacity
 Torque (250 bar)
 Max axial load static
 Max axial load dynamic
 Weight
 Connections
 Max oil flow
 Connectors

Unlimited
 250 bar
 200 bar
 300 bar
 420 cm³
 1100 Nm
 55 kN
 25 kN
 24 kg
 G3/8
 20 LPM
 BSP G3/8"

