

70400 CR 400-W25A30

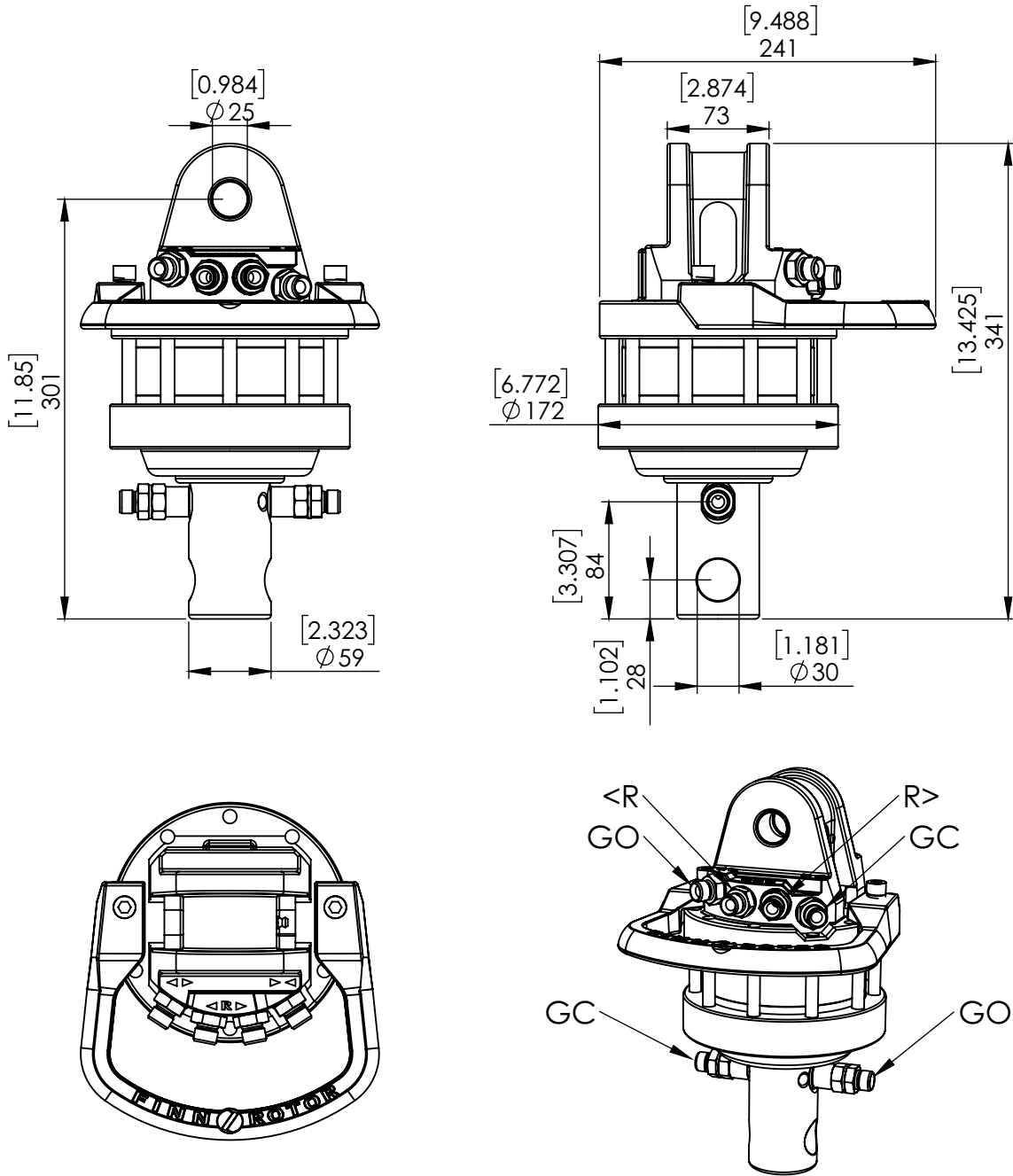

ROTATION ANGLE	UNLIMITED	
MAX PRESSURE (R) [BAR/PSI]	250	3625
MAX PRESSURE (GO) [BAR/PSI]	200	2901
MAX PRESSURE (GC) [BAR/PSI]	300	4351
DISPLACEMENT [cm ³ /Inch ³]	420	26
TORQUE [Nm/lbf-ft]	1100	811
MAX AXIAL LOAD STATIC [KN/lbf]	40	8992
MAX AXIAL LOAD DYNAMIC [KN/lbf]	20	4496
WEIGHT [kg/lb]	23	51
CONNECTIONS	G3/8"	G3/8"
REQ. OIL FLOW FOR ROTATION [LPM/GPM]	20	5.3