

70305-222 CR 300-W25F140-222

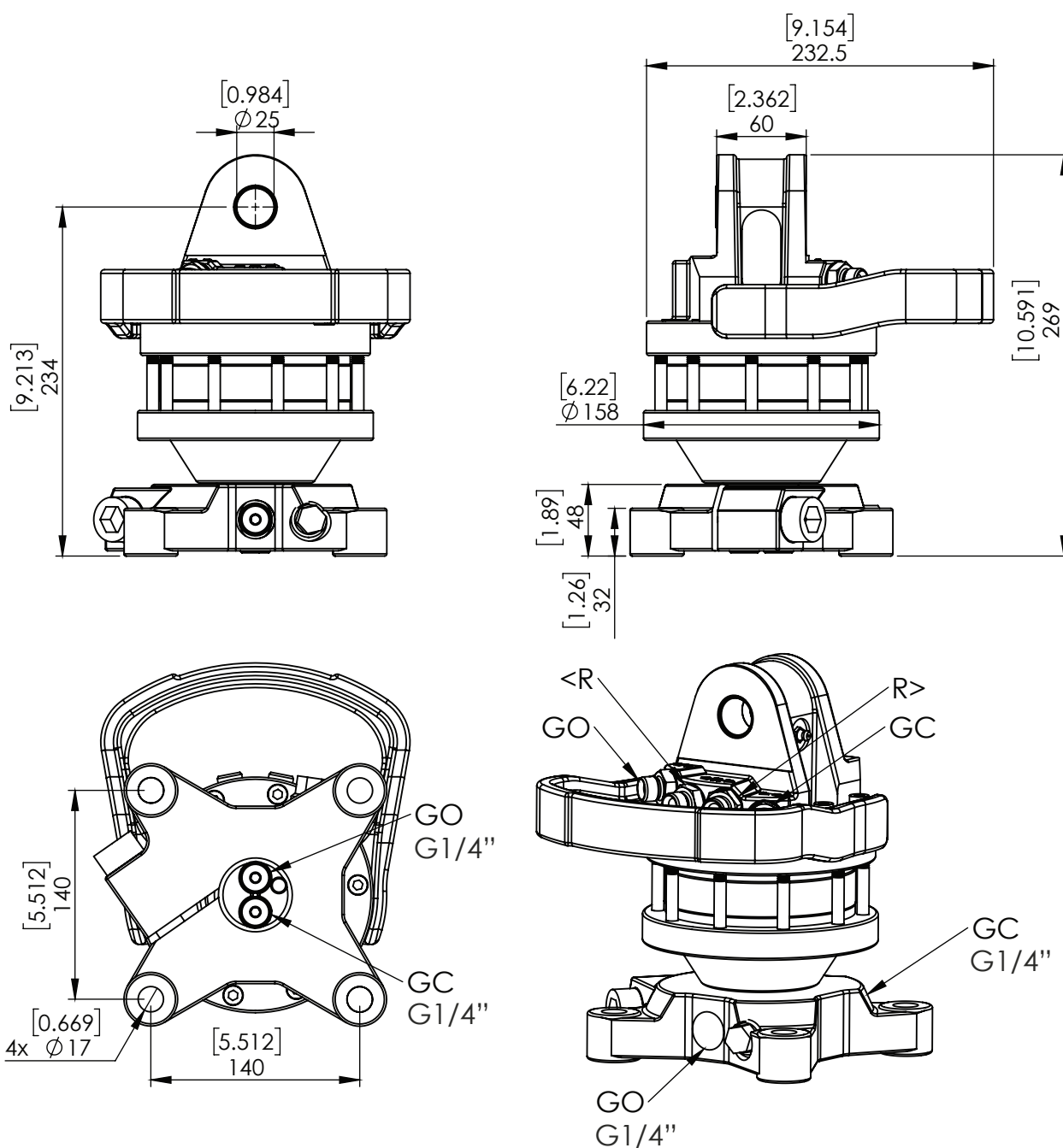

Rotation angle	Unlimited
Max pressure (R)	250 bar
Max pressure grapple open (GO)	200 bar
Max pressure grapple close (GC)	300 bar
Capacity	330 cm ³
Torque (250 bar)	900 Nm
Max axial load static	30 kN
Max axial load dynamic	15 kN
Weight	22 kg
Connections	G3/8
Max oil flow	20 LPM
Connectors	PSB G3/8"

