

60440-1B

CBL 6025-6025

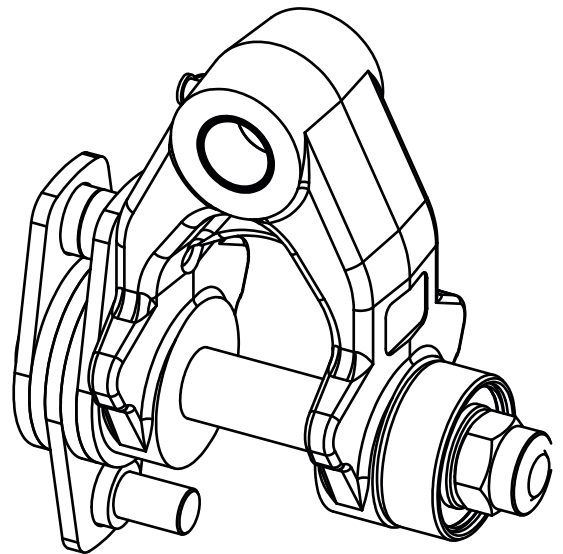
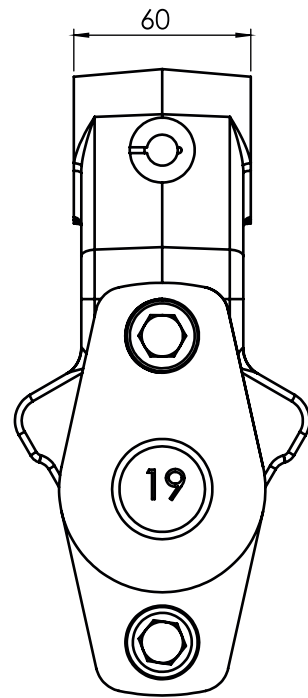
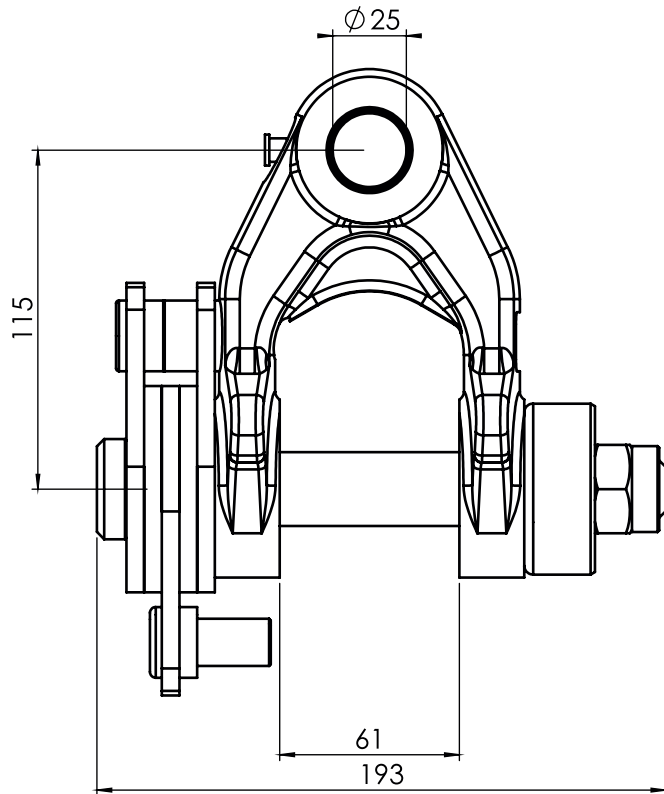

Max axial load static
Max axial load dynamic
Weight
Braking force

45 kN
25 kN
5,5 kg
120 Nm